

AERIAL DIMENSION CHART

AMATEUR RADIO ANTENNA LENGTH CHART

	FREQUENCY (Mhz)	1/4λ (Feet)	1/2λ (Feet)	1λ (Feet)	1/2λ Inv Vee 90° (Feet)
160 METERS	1.800	130' 0"	260' 0"	558' 4"	257' 5"
	1.850	126' 6"	253' 0"	543' 3"	250' 5"
	1.900	123' 2"	246' 4"	528' 11"	243' 10"
	2.000	117' 0"	234' 0"	502' 6"	231' 8"
80 METERS	3.500	66' 10"	133' 9"	287' 2"	132' 5"
	3.750	62' 5"	124' 10"	268' 0"	123' 7"
	3.900	60' 0"	120' 0"	257' 8"	118' 10"
	4.000	58' 6"	117' 0"	251' 3"	115' 10"
40 METERS	7.000	33' 5"	66' 10"	143' 7"	66' 2"
	7.150	32' 9"	65' 5"	140' 7"	64' 10"
	7.300	32' 1"	64' 1"	137' 8"	63' 6"
30 METERS	10.100	23' 2"	46' 4"	99' 6"	45' 10"
	10.150	23' 1"	46' 1"	99' 0"	45' 8"
20 METERS	14.000	16' 9"	33' 5"	71' 9"	33' 1"
	14.150	16' 6"	33' 1"	71' 0"	32' 9"
	14.300	16' 4"	32' 9"	70' 3"	32' 5"
	14.350	16' 4"	32' 7"	70' 0"	32' 3"
17 METERS	18.068	12' 11"	25' 11"	55' 7"	25' 8"
	18.168	12' 11"	25' 9"	55' 4"	25' 6"
15 METERS	21.000	11' 2"	22' 3"	47' 10"	22' 1"
	21.200	11' 0"	22' 1"	47' 5"	21' 10"
	21.450	10' 11"	21' 10"	46' 10"	21' 7"
12 METERS	24.890	9' 5"	18' 10"	40' 5"	18' 7"
	24.990	9' 4"	18' 9"	40' 3"	18' 6"
10 METERS	28.000	8' 4"	16' 9"	35' 11"	16' 7"
	28.500	8' 3"	16' 5"	35' 3"	16' 3"
	29.700	7' 11"	15' 9"	33' 10"	15' 7"
6 METERS	50.000	4' 8"	9' 4"	20' 1"	9' 3"
	54.000	4' 4"	8' 8"	18' 7"	8' 7"
2 METERS	144.000	1' 8"	3' 3"	7' 0"	3' 3"
	148.000	1' 7"	3' 2"	6' 9"	3' 2"

Antenna length calculations are based on the following formulas:
 1/2 wave dipole (feet) = 468/frequency in Mhz
 Full wave loop (feet) = 1005/frequency in Mhz
 Inverted Vee with 90 degree included angle is 99% the length of 1/2 wave dipole

Note:
 Cut wire slightly longer to allow for connecting insulators and pruning.
 Height above ground, nearby wires, trees, etc. will change tuning slightly.

MILLENNIA
ARTS

NOTE:
 ALL MEASUREMENTS ON THE CHART IS PER LEG

SIMPLE WIRE ANTENNAS THAT WORK

Dipole

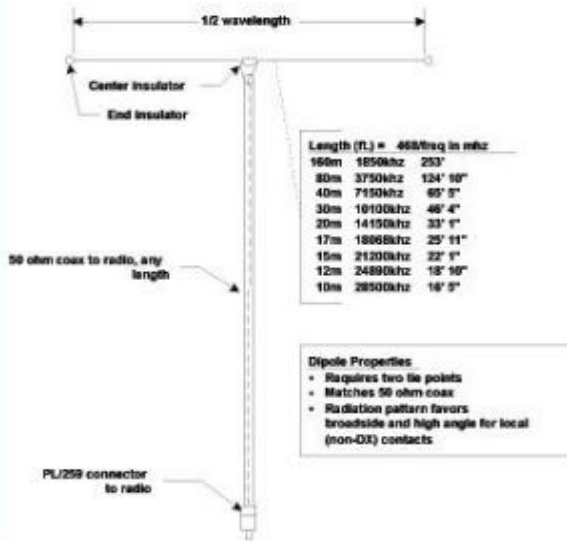

Inverted Vee

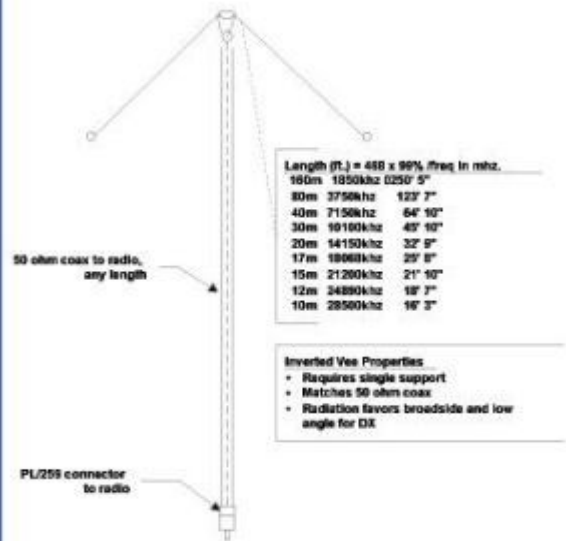

Full Wave Loop

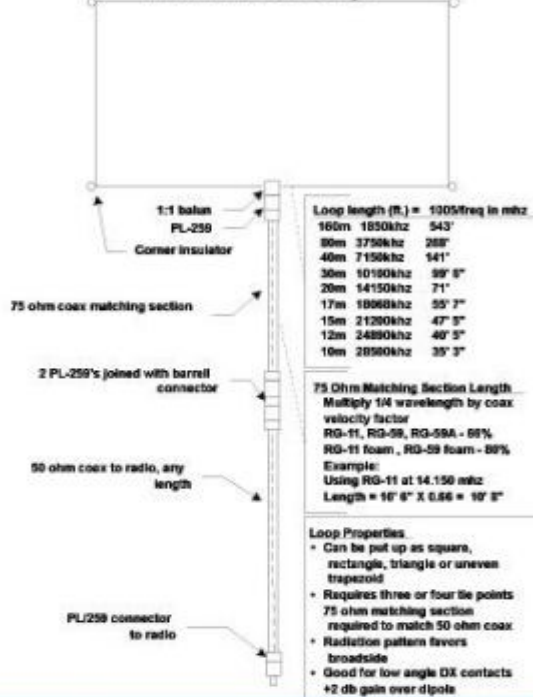

Ground Plane

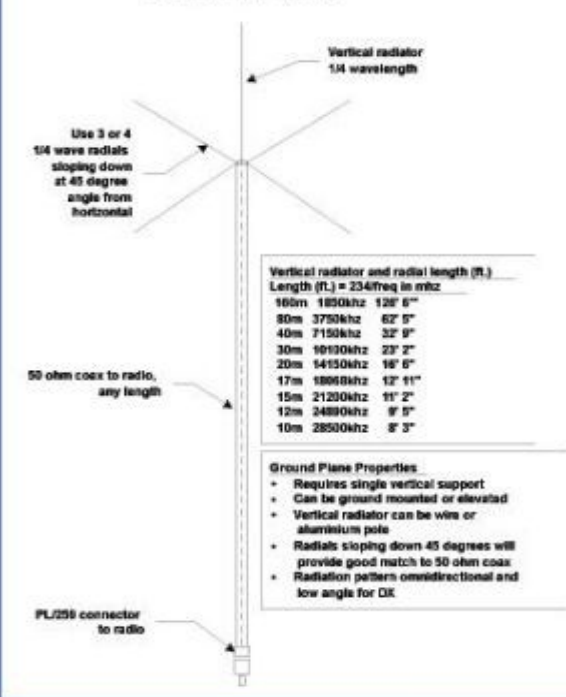

Original concept and design by
 George I. Wagner K5KG
 © 2012 Millennia Arts

A product of Millennia Arts
MILLENNIA
 www.millart.net ARTS

CLICK ON THE PHOTO FOR A LARGER IMAGE

STANDARD DIPOLE CONSTRUCTION

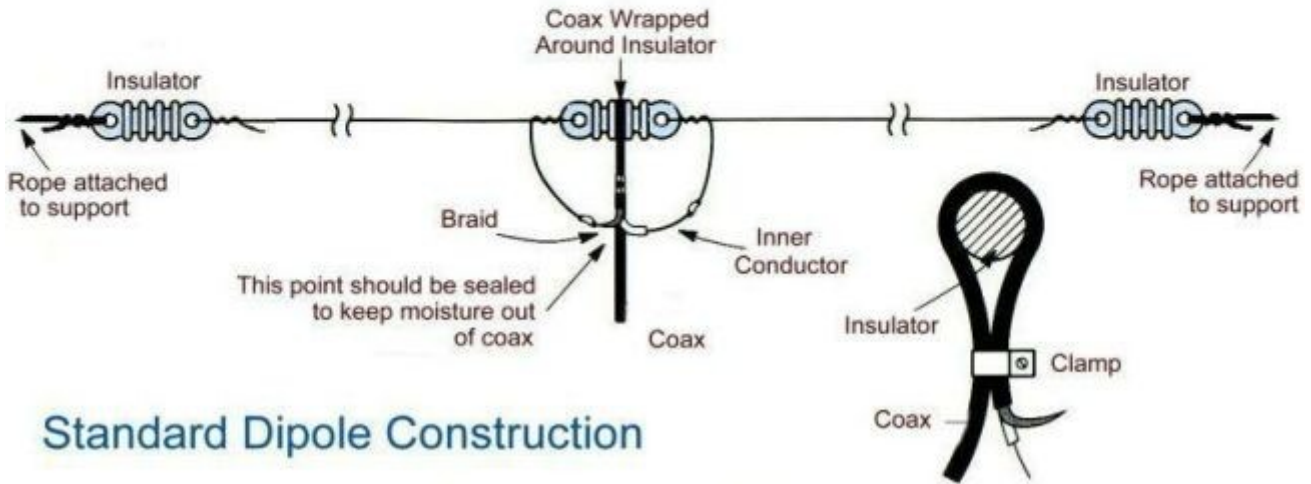
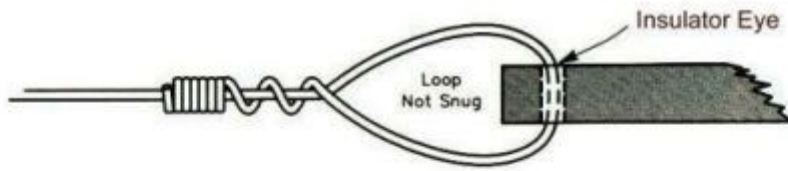

Standard Dipole Construction

ARROW ANTENNAS DUAL BAND J-POLE

J - VHF

Model

J146/440

Simply the Best

Does NOT require a ground plane.
 Mount on a metal mast
 Ideal for mounting in an attic,
 On a roof vent pipe, (up to 1 1/2")
 On a wooden or Fiberglass pole,
 On Fiberglass or Plastic Vehicles,
 (Motorhomes, Trucks, **Boats**)
 Mount it just about anywhere.

Low SWR - Wide Bandwidth
 Has Gain over a 1/4 wave .
 Omni-Directional.

This is a very Heavy Duty Antenna.
 The Elements are made from 3/8"
 Solid Round Aluminum with a Heavy
 Duty Angle Mounting Bracket.

Mounting Hardware for
 mast up to 1 1/2" Included.

Single SO239
 Feed Connector

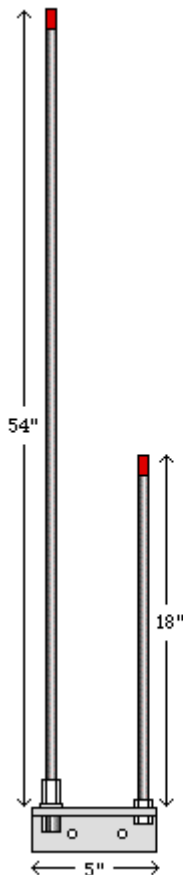

Covers 150 -162 MHz.
 With an VSWR of less than 1.5 - 1

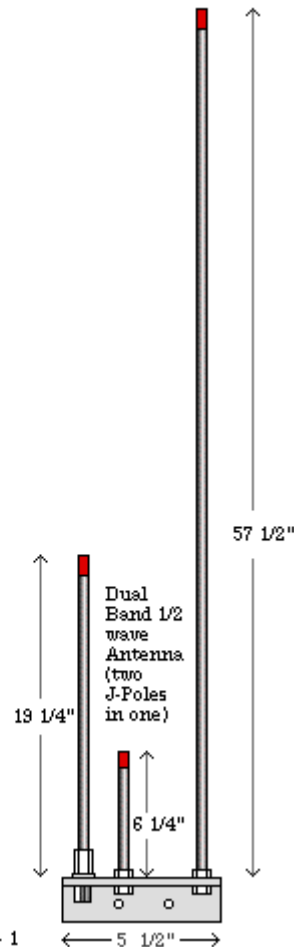

Covers 143-149 MHz. VHF
 Covers 437-450 MHz. UHF
 With an VSWR of less than 1.5 - 1

**Part
Description**

- 3/8" X 19 1/4" Element with Coupling Nut
- 3/8" X 6 1/4" Element with 2 Stainless Nuts
- 3/8" X 57 1/2" Element with 2 Stainless Nuts
- 1 1/2" X 1 1/2" X 5 1/2" Assembly / Mounting Bracket
- SO-239 Stud
- Nylon Shoulder Washer

Assembly Steps

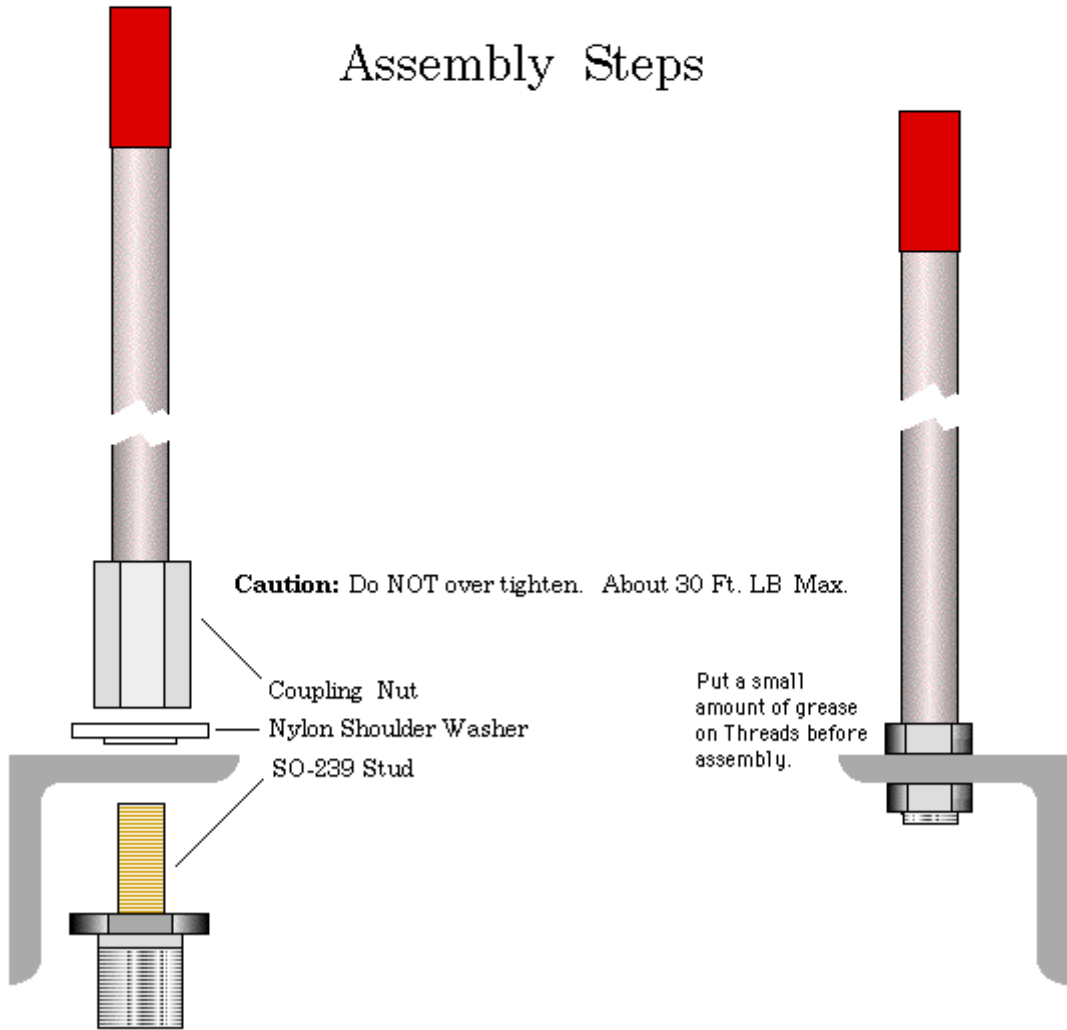

1 1/2" X 1 1/2" X 5 1/2" Assembly / Mounting Bracket

